



微信公众账号



FACEBOOK

安徽长庚光学科技有限公司

[www.laowalens.com](http://www.laowalens.com)

服务热线:400-066-1316

Email: [sales@laowalens.com](mailto:sales@laowalens.com)

电话Tel:(+86) 551-69107990

地址: 合肥市庐阳区天水路与太和路交叉口庐阳中科大校友创新园5号楼

Add: Building 5, USTC Alumni Innovation Park, Crossing of Tianshui  
and Taihe Road, Luyang District, Hefei City, Anhui Province, China

FFII 10mm F2.8 C&D Dreamer

使用手册  
Instruction Manual

**LAOWA 老蛙**

本公司保留更改产品设计与规格的权利, 届时恕不另行通知;  
本公司保留对此《使用说明》的最终解释权。  
Please note we reserve the right to change our product's  
design and specifications at any time without notice and  
to the final interpretation of the *Instruction Manual*.



## 前言

真诚地感谢您选购 LAOWA FFII 10mm F2.8 C&D Dreamer广角镜头。此镜头是无反全画幅系统超广角镜头，采用轻量化设计，轻便小巧。



(MF)



(AF)



为了操作上的安全，使用本产品前请务必仔细阅读使用手册与注意事项，并将手册放在需要时容易取得的地方。如遇到不能解决的问题请通过售后电话获取技术支持。

## 主要特色

- 1、镜头采用轻量化设计,大小为 $\phi 82\text{mm} \times 72.8\text{mm}$ ,重量约420g,搭配在全画幅机身上使用,握持感均衡,轻便携带。
- 2、10mm焦段,视场角 $130.4^\circ$ ，“零”畸变的光学特性,画面中的线条横平竖直。5片光阑叶片设计,可以小光圈情况下轻松拍摄出十针耀眼光芒。
- 3、内部有9组15片镜片,包含3枚异常分散玻璃和2枚非球面镜片的结构带来的高素质成像。外有全金属材料制成的机械结构,保障了镜头长期使用的耐用性。
- 4、索尼E卡口和尼康Z卡口为自动对焦设计,可实现自动对焦且可以机身调节光圈,记录拍摄信息。

## 注意事项

### △ 安全注意事项

- 切勿自行拆解、修改或改装。当产品由于外力原因破损,切勿触碰外露部分或破损边缘处。
- 切勿放置于直射阳光下、封闭车辆中或其余高温处,否则过高的温度会使镜片和其他部件产生伸缩变形。
- 不使用镜头时,请将镜头前盖盖上或置于没有阳光照射处。凸透镜反射出的光线可能会聚集在附近物体上,导致发生火灾。
- 在逆光拍摄时,切勿将太阳置于画面中心,应该使太阳充分偏离画角,否则阳光会在相机内部聚集并导致火灾或灼伤眼睛。
- 在使用相机内置闪光灯拍摄时,由于镜头本身会遮挡光线而产生渐晕,因此建议您使用外设闪光灯拍摄。

## 注意事项

### 长期使用保养注意事项

- 避免触摸镜头表面,应用专用镜头布或气吹去除镜头表面的尘埃,不使用镜头时,应将镜头盖盖上。
- 使用镜头纸或镜头布清洁时,以螺旋的方式从中间向外擦拭镜头上的污垢以及指印。
- 镜头从寒冷的环境突然转移至温暖的环境时,镜头的外部以及内部镜片将会凝结水雾,所以在转移时应采取防潮保护措施。

## 各部件名称

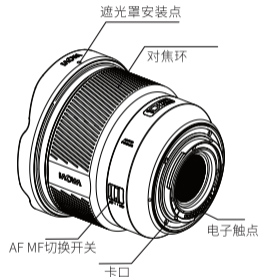
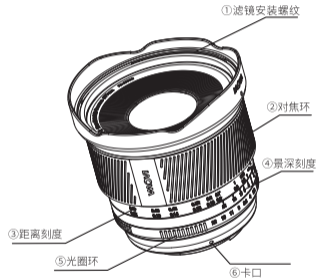

## 使用说明

### ■ 镜头安装

取下镜头后盖。将镜头卡口⑥上的安装标记对准相机座圈上的对应标记, 随后将镜头插入机身座圈, 根据所购买卡口的安装方向旋转镜头, 直至咔嚓声锁紧镜头。安装时请不要用力过猛, 以免导致卡口损伤。

### ■ 镜头拆卸

关机后按住相机上的镜头释放按钮, 依照所购买卡口的安装方向反向旋转镜头, 随后将镜头从座圈中拔出。

装上镜头后, 请尝试旋转镜头确认是否已将其固定在相机上。

### ■ 对焦

此款镜头分自动对焦版和手动对焦版

全手动对焦镜头, 合焦时, 缓慢旋转对焦环②, 直至合焦, 自动对焦镜头, 根据选择的对焦点和对焦模式, 进行自动对焦。

不要过猛过快地旋转对焦环, 避免用力过度损坏对焦环部件。

镜头上的距离刻度是出于指导目的。实际焦点可能同刻度标记稍有不同。

如需要非常精确的对焦, 请在固定好相机位置的情况下使用最大光圈对焦, 对焦完成后旋至所需要的光圈值。

为了对焦的方便性, 请开启相机内的峰值对焦功能(视所使用相机功能而定)。

## 光圈使用

光圈在镜身上调节,根据拍摄环境和与所需要的景深,转动光圈环来选择对应的光圈。

索尼E、尼康Z卡口为自动对焦镜头,可通过机身调节光圈,其他卡口无CPU数据,无法记录光圈参数。

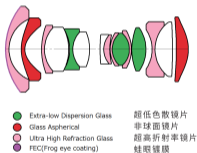
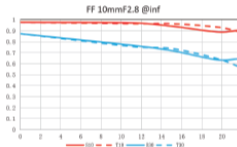

## 规格表

FFII 10mm F2.8 C&D-Dreamer	
画幅	全画幅
焦点距离	10mm
光圈范围	F2.8-22
视场角	130.4°
镜头结构	9组15枚(2片非球面,3片ED镜片)
光圈叶片	5片/14片
最近摄影距离(物像距离)	12cm
最大放大倍率	0.24倍
合焦驱动方式	自动/手动
滤镜尺寸	Φ77mm
镜头尺寸	φ82mm*72.8mm
重量	AF E口:约420g(不含前后盖)
卡口	E/RF/Z/L
AF卡口	E/Z(5片光圈叶片)
MF卡口	E/RF/Z/L(14片光圈叶片) RF/L(5片光圈叶片)



## Preface

Thank you very much for purchasing LAOWA FFII 10mm F2.8 C&D Dreamer wide angle lens. This is an ultra-wide angle lens for mirrorless full-frame systems. It adopts lightweight design and is compact.



(MF)



(AF)

 *For operational safety, please read the manual and precautions carefully before using this product, and keep the manual at a place that is easily accessible when needed. If you encounter a problem that cannot be solved, please ask for technical support through email.*

## Features

- 1.The lens is compact and lightweight with the dimension of  $\phi 82\text{mm} \times 72.8\text{mm}$  and the weight of 420g. It can be used on full-frame cameras. It has good handling and is portable.
- 2.The lens provides a 10mm focal length and the angle of view is  $130.4^\circ$ . Due to its optical characteristic of “zero” distortion, all the horizontal and vertical lines in the images are in right positions. With the design of 5 aperture blades, 10-rayed sunstar effects can be easily shot in small aperture situations.
- 3.The lens consists of 15 elements in 9 groups, including 3 ED glasses and 2 aspherical glasses, which can bring high quality imaging. The lens is all-metal constructed, ensuring its durability.
- 4.Sony E mount and Nikon Z mount versions adopt autofocus design, which can realize autofocus. Besides, aperture can be adjusted on the camera and shooting information can be recorded.

## Precautions

### ■ Safety Precautions

- Do not disassemble, modify the lens by yourself. Do not touch the internal parts that become exposed as the result of external force.
- Do not leave the lens where it will be exposed to high temperatures, such as in direct sunlight and an enclosed vehicle. Excessive heat may deform the glass elements and other parts of the lens.
- Whether it is attached to the camera or not, do not leave the lens under the sun without the lens cap attached. This is to prevent the lens from concentrating the sun's rays, which could cause a fire.
- Do not place the sun in the frame center when shooting with backlight. Doing so might cause a fire or harm your eyes. The camera's built-in flash will cause vignetting if used with this lens. For best results, please use an external flash unit.



## Maintenance Precautions

- Do not touch the surface of the lens directly. Brush off any dust with a blower. Wipe the surface with a cleaning cloth or a lens tissue.
- Try a circular motion from the center outward to remove oil, fingerprints and grime on the lens surface.
- If your lens is brought directly from a cold place to a warm place, condensation may appear on the lens. To avoid this, be sure to take some action to protect the lens.

### Name of each part

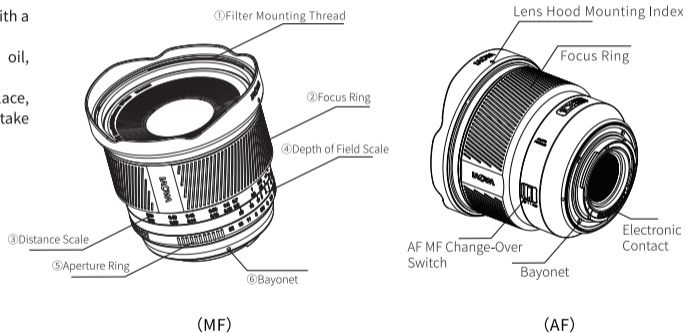

## Instructions

### ■ To attach the Lens

Remove the rear lens cap. Align the mounting index ⑥ on the lens bayonet with the mounting index on the camera. Place the lens on the camera mount, then rotate the lens according to the proper direction of the mount type until it locks. Do not use excessive force during installation to avoid damage to the bayonet.

### ■ To remove the lens

Turn the camera off. While pressing and holding the lens release button on the camera, rotate the lens in the reverse direction for attaching the lens until it stops. Then, detach the lens. After installing the lens, please try rotating it to make sure it is fixed to the camera.

### ■ Focusing

The lens has two versions, the autofocus version and the manual focus version.

For the manual focus version, rotate the focus ring ② slowly to get focus.

For the autofocus version, autofocus is realized according to the selected focus and focus mode.

Turn the focus ring slowly and gently to prevent it from damage.

The distance scale on the lens is for instructional purposes. Actual focus may slightly differ from those scale indications.

To get precise focus, it is recommended to focus wide open when the camera is fixed. Get focus first, then set the desired aperture by turning the aperture ring.

Turn on the focus peaking on the camera to help focusing. (Note that the function depends on camera models.)

## ■ Setting the Aperture

Aperture is set through the aperture ring on the lens. According to the shooting situation and desired depth of field, rotate the aperture ring on the lens to the corresponding aperture.

Sony E mount and Nikon Z mount versions adopt autofocus design, which enables users to adjust the aperture on the camera. Other mount versions have no CPU data, therefore, the aperture values cannot be recorded.

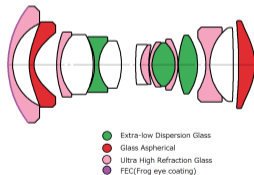
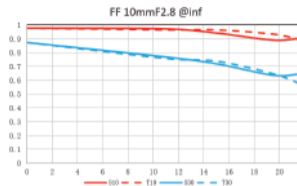

## Specifications

FFII 10mm F2.8 C&D-Dreamer	
Format Compatibility	Full Frame
Focal Distance	10mm
Aperture Range	F2.8-22
Angle of View	130.4°
Lens Structure	15 elements in 9 groups (2 Aspherical glasses, 3 ED glasses)
Aperture Blades	5/14
Min. Focusing Distance (Object Image Distance)	12cm
Max. Magnification	0.24X
Focus Mode	AF/MF
Filter Thread	Φ77mm
Dimensions	About φ82mm*72.8mm
Weight	AF E :About 420g (Without front cap and rear cap)
Mount	E/RF/Z/L
AF Mount	E/Z(5 Aperture Blades)
MF Mount	E/RF/Z/L(14 Aperture Blades) RF/L(5 Aperture Blades)

